

Remote control functionality

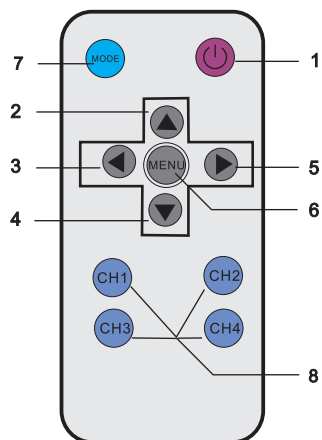

1. Power ON/Off
2. Up
3. Left
4. Down
5. Right
6. Menu
7. Split image/View switch
8. Full screen display of the selected channel

Technical assistance

If you need assistance setting up or using your Gator product now or in the future, call Gator Support.
Australia

TEL: 03 – 8587 8898

FAX: 03 – 8587 8866

Mon-Fri 9am – 5pm AEST

Please retain this user guide for future reference.

If you would like to download a digital copy of this manual, or other Gator manuals/software, please visit the <http://gatordriverassist.com> website and click on 'Firmware & Manuals' for information on where to find the manuals/software.

This manual is considered correct at time of printing but is subject to change. For latest manuals and updates refer to the website.

Copyright © 2017 by TDJ Australia

All rights reserved. No part of this publication may be reproduced, distributed, or transmitted in any form or by any means, including photocopying, recording, copying or other electronic or mechanical methods, without the prior written permission of the author.



www.gatordriverassist.com



GATOR

TRADE series

GT90450

9" Quad-Display Monitor with Heavy Duty Camera



3 YEAR WARRANTY

PRO LINK II

Before operating the Monitor, please read this manual thoroughly and retain it for future reference.

Inclusions

- 1 x Hi-Resolution Monitor
- 1 x CMOS camera
- 1 x Wire harness
- 1 x Sun shade
- 1 x U-bracket
- 4 x U-bracket screws
- 1 x Remote controller

Product structure

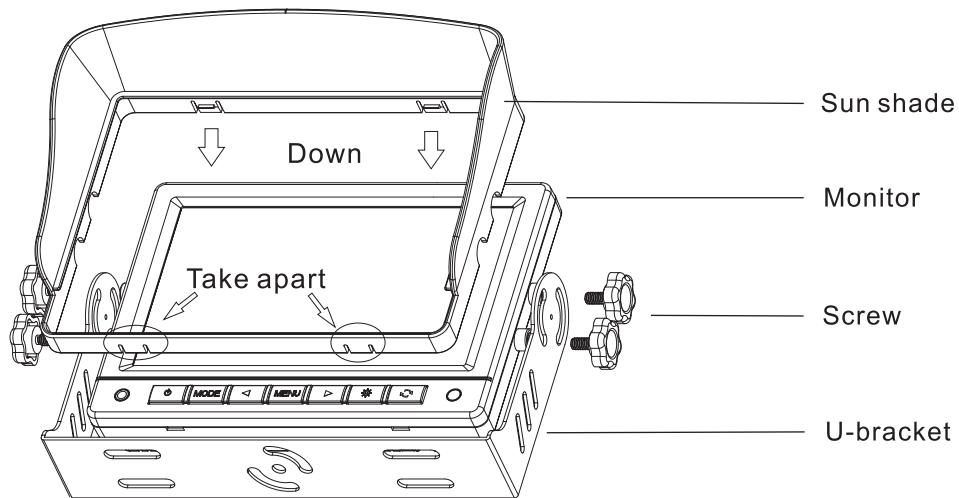

Monitor Features

- 9" High Resolution Monitor
- Resolution 1024x600 RGB
- Bright 450CD Display
- Aspect Ratio: 16:9
- 4X Video Inputs
- Single/Split/Quad Display Selectable
- PAL/NTSC Auto Switching
- 10 Metre Main harness Prolink II
- Rear View Delay (0~15S selection)
- High/Low Voltage & Short Circuit Protection
- 12/24 Input Voltage
- Detachable Sunshade
- Supplies 12V Power to Cameras

Camera Features

- CMOS Image Sensor
- 120 Degree Wide Angle Lens
- Rated *IP69K* Waterproof
- NTSC
- Minimum Illumination: 0 Lux
- 10 IR LED's
- 1/4" Image Sensor

Monitor functionality & settings

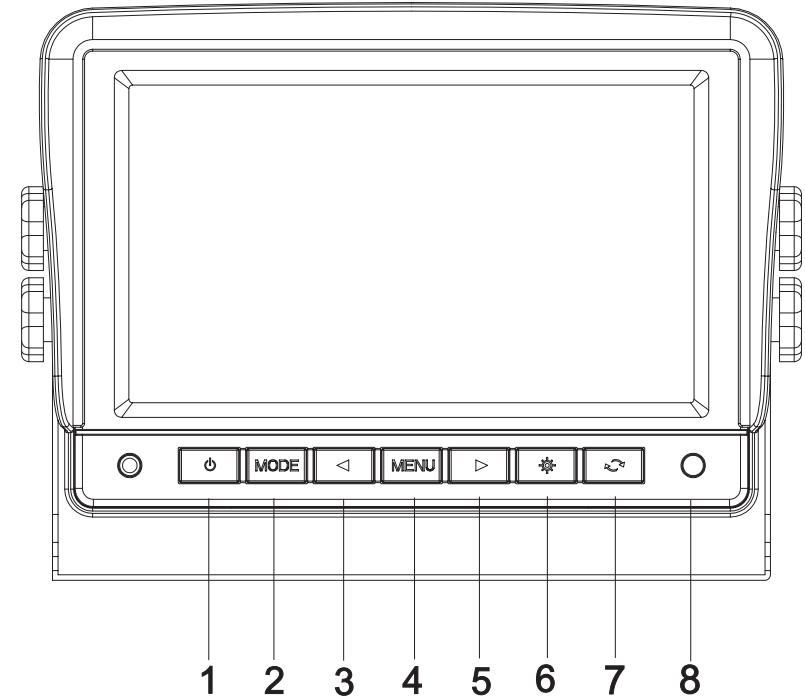

1. Power ON/Off
2. Camera input viewing modes.
3. Left
4. Menu
5. Right
6. Picture (Standard, Soft, Vivid, Light)
7. Scan mode
8. Remote sensor

Menu structure

When pressing the buttons on this unit be sure to hold the button down long enough for the unit to register. Press the Menu button once to scroll through each menu item. Keep pressing the Menu button to advance to the next set of menus. To scroll down to the item you wish to change press the Mode button. Use the left and right arrow buttons to change the value of the menu item selected. To exit the menu system simply wait 6 seconds without pressing any buttons. The menu structure is in the following sequence.

Picture, System, Mirror, Delay.

1. **Picture:** Bright(ness)/ Contrast/ Color (Saturation)/ Tint/ Reset
2. **System:** Language/ Guidelines/ Show mode
3. **Mirror:** Front Cam/ Back Cam/ Left Cam/ Right Cam
4. **Delay:** Front Cam/ Back Cam/ Left Cam/ Right Cam

Menu item descriptions.

1. Picture:

Brightness: Adjusts the brightness of the screen. Be careful not to adjust this setting to high as this will reduce the contrast (blacks will eventually become greys reducing the contrast to whites)

Contrast: Adjust the transitions of highlighted areas to darkest shadows. A higher contrast makes the image appear sharper, but too much contrast will remove subtle details in the mid tones.

Colour (Saturation): This adjusts the colour saturation. Higher levels yield more colour, however too much colour may affect night time performance (may result in a noisy image).

Tint: This function adjusts the colour hue of the monitor. It shifts the monitor's colour in the red direction if you decrease the number and it shifts it to the green direction if you increase the setting.

Reset: Returns the unit to factory settings.

2. System:

Language: There are 9 different language settings including popular languages such as German, French, Chinese, Italian, and Spanish.

Guide lines: When selected to be on the rear camera channel will have parking guide lines added to the image when it is triggered. When the Ch2 (back) camera is selected manually no guide lines are present.

Show mode: When selected on each channel will be labeled on screen with its image. For example: Ch2 will be labeled "Back" Ch1 will be labeled "Front".

3. Mirror:

Front Cam, Rear Cam, Left Cam, Right Cam: Depending on the direction of the camera, you may wish to change the orientation of the image for each camera. An example of this function would be in the event you have a forward facing camera and a rear facing camera. One of these images is best viewed as a mirror image (the rear view) and the other as a normal view (the front facing camera). This model is capable of selecting mirror mode individually for each camera.

4. Delay:

Front Cam, Rear Cam, Left Cam, Right Cam:

A delay off can be set for each camera channel of up to 10 seconds. This sets the switch off time after the trigger is removed. This function operates when a camera is triggered. For example the vehicle is in reverse and so the back up light wire of the car triggers the back camera to turn on automatically. When the trigger is lost (the vehicle is taken out of reverse) the image is normally switched off or the monitor returned to its previous state. Delay time allows the camera to stay on for a prescribed amount of seconds after the trigger is lost.

Using delay for blind spot priority when changing lanes. The off delay can be used to keep a camera on when a trigger is intermittent like in the case of using the indicator bulb positive as a trigger to turn on a camera that views the blind spot on that side of the vehicle. When set to as little as 3 seconds the camera will stay on when changing lanes with the indicator on even though the trigger is not constant (on/off, on,off etc etc).

Common Trailer pin configurations (Always check your individual trailers wiring in case its not standard)

Pin	Connection	Colour
1	Left Indicator	Yellow
2	Auxiliary or Reverse Light	Black
3	Earth	White
4	Right Indicator	Green
5	Electric Brakes	Blue
6	Stop Light	Red
7	Tail Lights	Brown

Pin	Connection	Colour
8	Left Indicator	Orange
9	Auxiliary or Reverse Light	Pink
10	Earth	White
11	Right Indicator	Grey
12	Electric Brakes	Violet

Quad wiring diagram

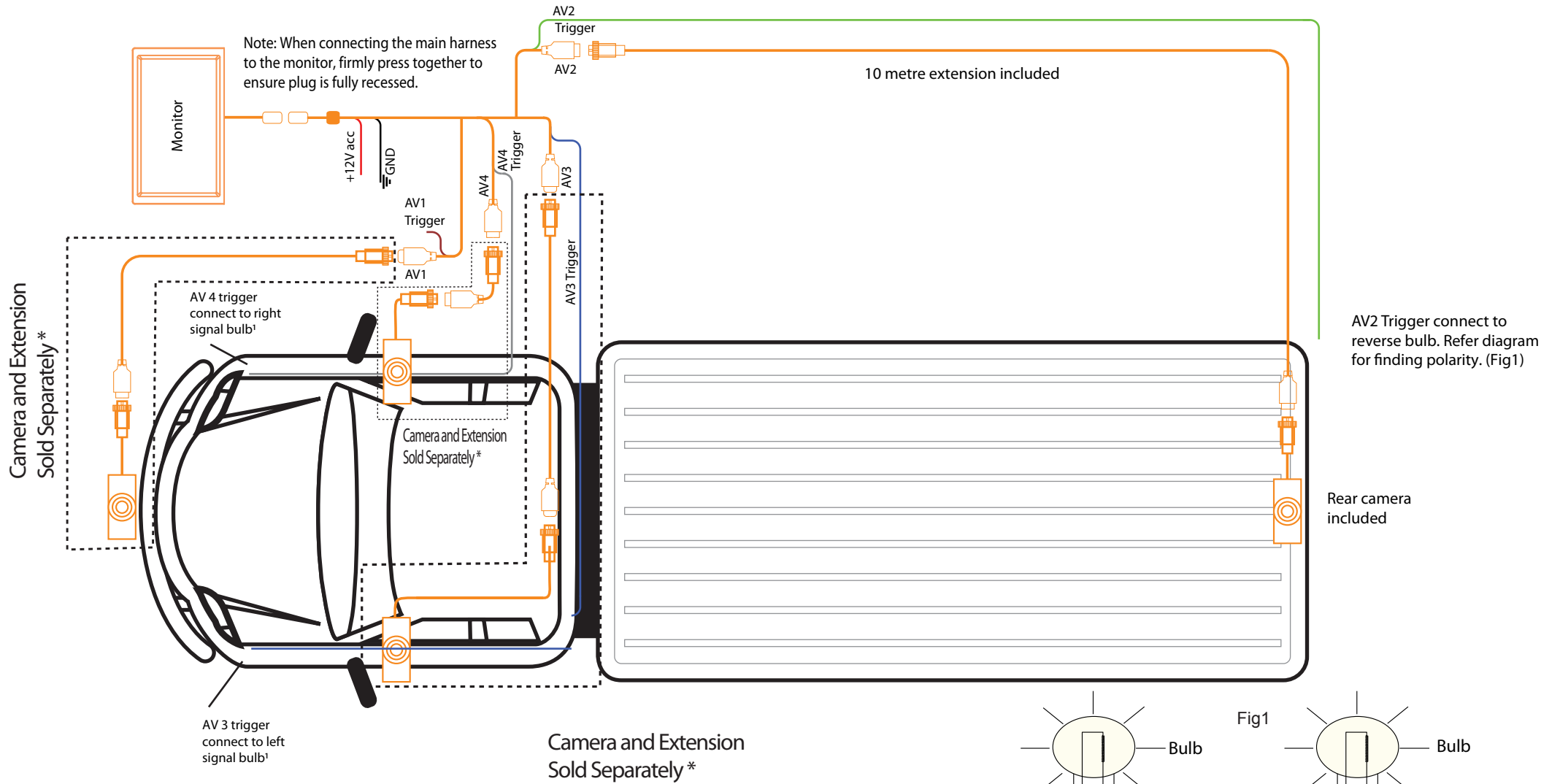

*Note: When side cameras are used for blind spot view connect the trigger wire for the left camera to the left signal bulb positive and do the same for the right camera. Add a delay time of around 5 seconds to left and right cameras to compensate for the intermittent triggering from the turn signal bulb.

* Trailer Kit Model	**Extension Model	*** Add on Camera Models
GTTKIT	PLC5	GT14SD
	PLC10	GT16SD
	PLC15	GT17SD
	PLC20	G354C

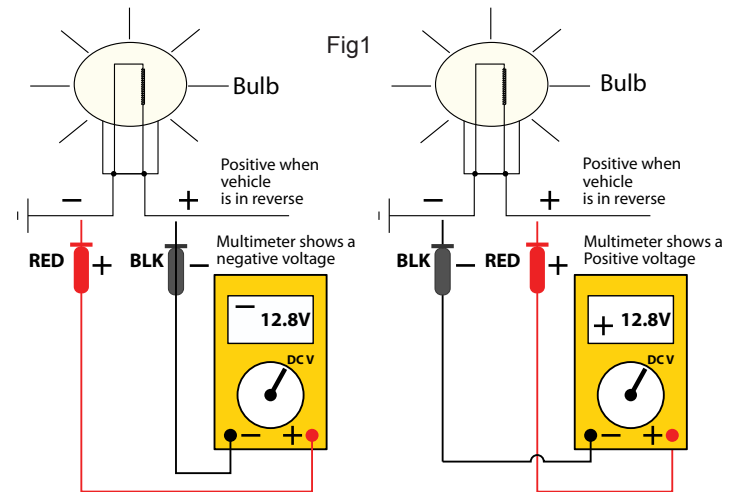

How to find reversing wires to trigger or power backup camera systems.

We recommend that you wire up the triggers as the last part of your installation (after the systems monitor has been wired) this is so that you can use the system as a safe way to test for a reversing wire.

Back up camera systems (reversing camera systems) require a signal to “Trigger” the system into action so that it automatically operates when the vehicle is in reverse.

Whilst some systems are designed to allow cameras to operate even when the vehicle is not in reverse it is still necessary to wire a trigger system in so that the Camera that is facing backward automatically turns and or takes over as priority when in the vehicle is in reverse. When wired in correctly using the right trigger priority, the system can also automatically turn on the rear camera of an attached trailer taking priority over the vehicles back up camera when the trailer is connected.

The most common way to trigger the rear facing camera is to use the + wire that powers one of the vehicles reversing globes at the back of the vehicle.

NOTE: Some vehicles that Use CAN bus to operate rear lighting systems may require additional parts to trigger the system.

Caution: Never test for reversing wires standing at the back of the vehicle, with the engine running and the gearbox in reverse gear. If the car/truck can not be placed in reverse without the engine running, Special procedures should be employed. In this case we highly recommend you seek a professional installer to do this type of work. Failure to follow proper procedure could cause serious injury or death. (The vehicle could back over you)

Step 1.

Place the car in reverse, with ignition on but the car not running (do not leave the cars ignition on for long periods of time without starting it) observe or have an observer notice which light turns on and its location in the lens. Turn the ignition off. Then, locate the globe socket that holds the reversing globe into the lens. In some cases the Lens has to be removed from the car to expose the socket. In most cases however, you can gain access from the inside of the car behind a removable interior wall/panel.

Step 2.

Identify which wire is the globes ground and which is positive (see Fig 1 diagram). Light globes have very low resistance so if a globe is in place, both wires will show up as a ground. Even if you remove the globe the second globe on the other side of the vehicle will still give the positive side a short path to ground and may still be indistinguishable from the globes earth. For this reason it is necessary to energize the globe to find out which side is positive and which side is negative.

Using a multimeter set to DC volts (make sure that it is on the correct scale) attach the negative probe to one of the globes wires and the positive probe to the other (in most cases you can push the probe ends into the back of the globe socket) if not, you may have to

carefully strip both wires sheaths back to expose the wires core making sure you keep them separate and away from the cars chassis to avoid any shorts). You should also make sure the globe it self is not resting on something that could be harmed by extreme heat as the globe when on can get very hot). Turn the ignition back on again with the cars gear set to reverse (without the engine running). The globe should illuminate and the multimeter will show a positive voltage or a negative voltage across the globe. By noting whether the voltage is positive or negative you can define which wire is positive or negative. If the reading is positive then the probes positive is connected to the positive wire. If it's a negative reading then the multimeter's negative probe is connected to the positive wire of the globe as a final check, take the vehicle out of reverse with the ignition still on and check that the voltage is now zero.

If the vehicle can not be placed in reverse without the engine running the following procedure should be used. With the car off, remove the globe. Set your multimeter to resistance on the lowest setting. Place one probe on a part of the chassis that is ground (most rear tail light assemblies have a small grounding screw close by). If you can not find one look for some exposed chassis (like a tailgate hinge etc). Measure the resistance to ground of both wires in the back of the globe socket (with the globe out) whilst the resistance will be very similar (because of the other globe still in the circuit) one wire will have a slightly higher resistance. The one with the highest resistance should be the positive wire.

Connect the system to this wire and then use the reversing system to test if it is triggering. With no one at the rear of the vehicle. Start the car. Make sure the reversing systems monitor is in the off state and then place the vehicle in reverse. If you have found the correct wire the system will automatically turn on from its off state. If you have connected the trigger to the globes earth no harm is caused but the system will not trigger. In that case simply connect it to the alternate wire and repeat.

CAN BUS

In the event that the cars reversing lights are driven by CAN BUS the above wiring system may not trigger the system correctly. It may even create a globe fault warning. In this case a CAN BUS module (sold separately) may need to be installed. However, just because the vehicle has a CAN BUS system does not necessarily mean that it will require such a module to work. In fact the opposite is true. Most vehicles do not require an additional module. If a CAN BUS module is required we recommend seeking advice from a professional installer.

Multi trigger systems. Please refer to the diagram provided with trailer trigger systems. Pay special attention to the AV camera numbers and trigger numbers. It is important that the AV camera numbers match the diagrams placement in order to provide the correct priorities so that when a trailer is connected it takes rear view priority over the vehicles rear view camera and so that when no trailer is connected the vehicles rear camera operates automatically.

GT904SD configurations

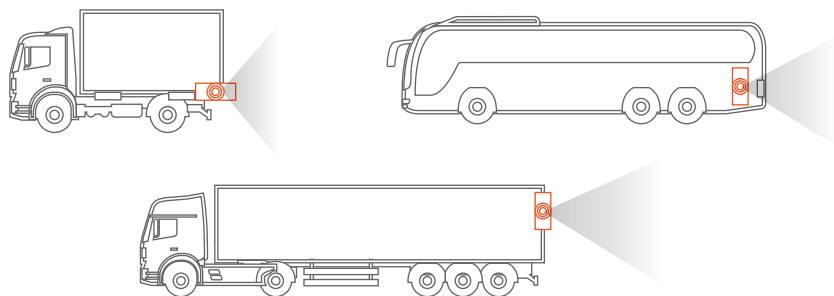

This system comes with one camera as illustrated above, however it is capable of running up to 4 cameras and can cover a very large array of vehicle requirements. The following diagrams show some additional (but not all), configurations that the system is capable of handling with the addition of some extra cameras and associated accessories. Please refer to our web site for detailed schematics of these installations.

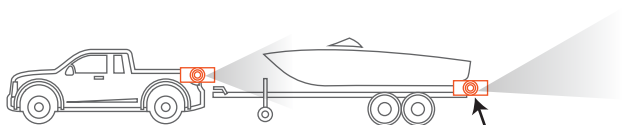

This camera can be used for reversing or as a rear-view mirror substitute

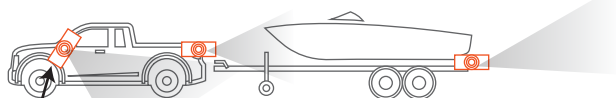
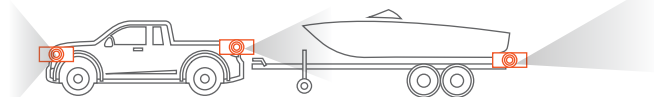

Turn signal activated used as blind spot detection

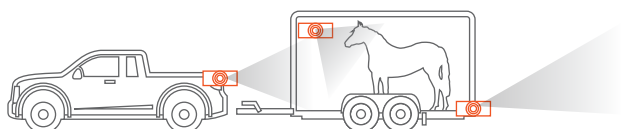

Turn signal activated used as blind spot detection

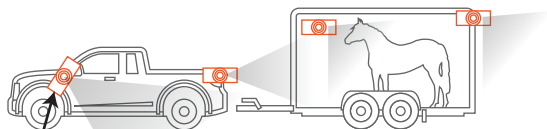

Turn signal activated used as blind spot detection.

Having two cameras at the back, one camera can be optimised for parking (top down view) whilst the other can look backwards and be used as a rear-view mirror substitute.

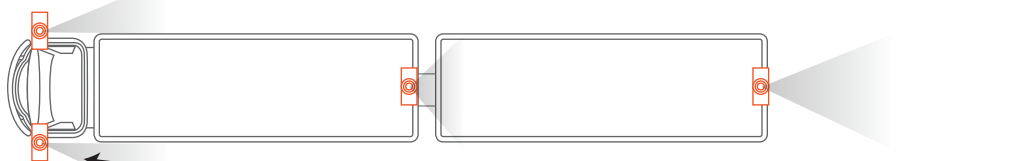
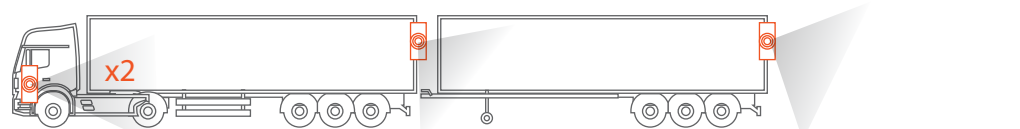
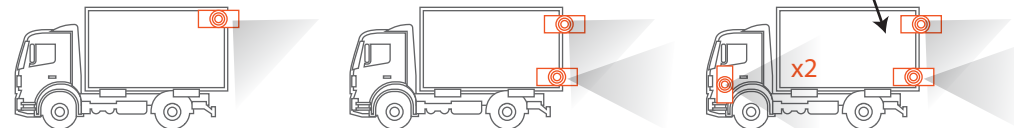

Turn signal activated used as blind spot detection

Scan the QR code to go to our website. Click on the icon for a full schematic wiring diagram to suit your installation.

Note: Additional cameras and wiring may be required depending on your application, compatible products are available on our website.

